

工艺说明

翻页册子，请自行排版

纸张：128g哑粉纸

颜色：黑+橙



PANTONE 165C

装订：骑马钉

尺寸：160*160mm（切圆角）

封面封底单面覆哑膜

封底

封面

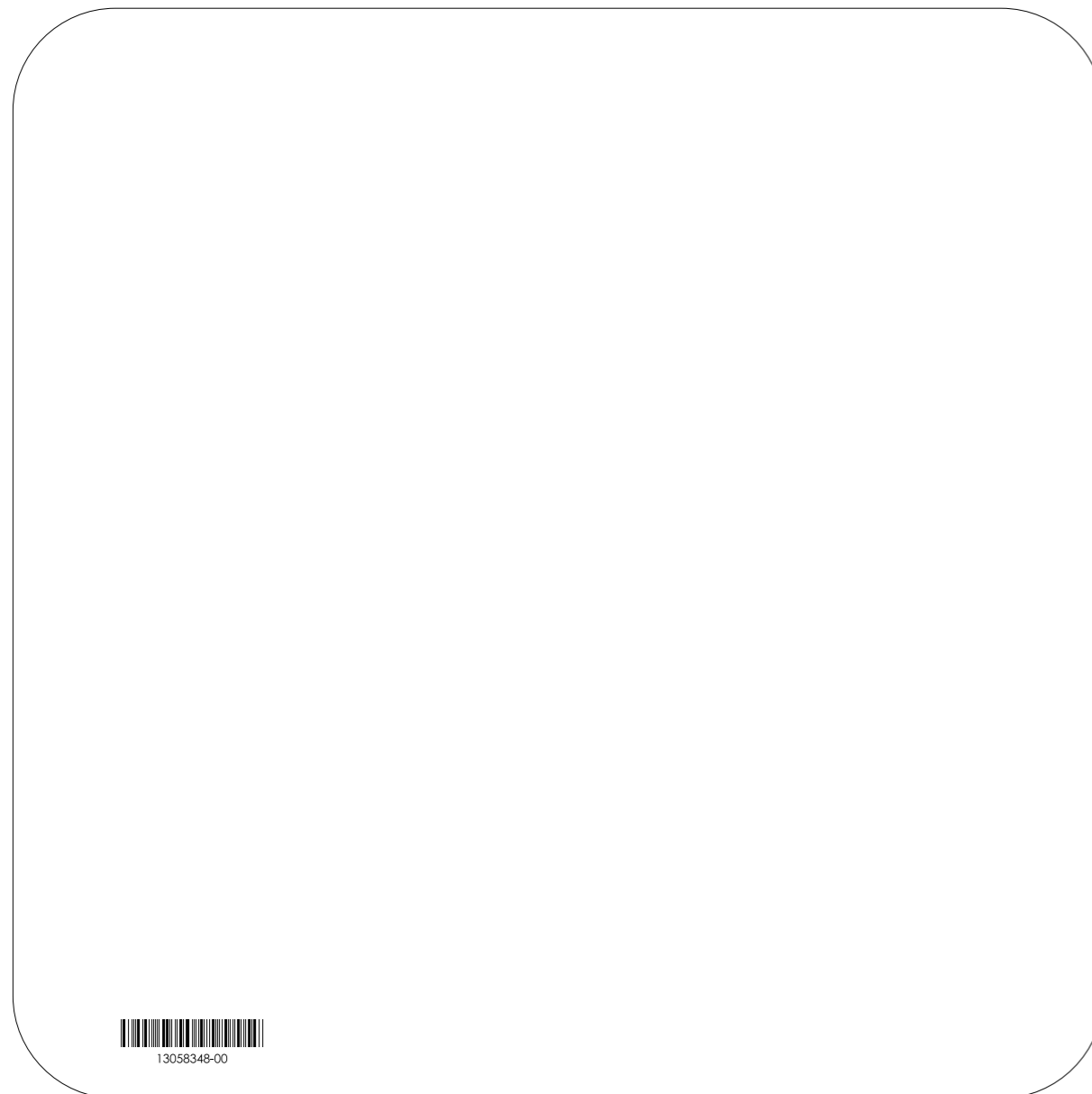

自助服务终端共有以下三款选配

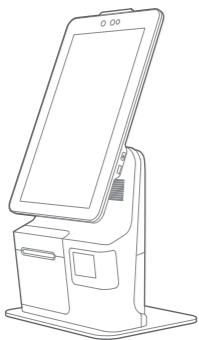

15.6" 屏
(单屏)

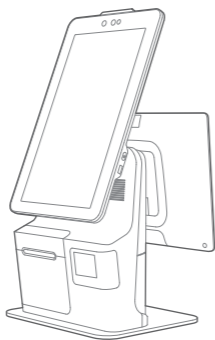

15.6" 主屏+15.6" 副屏
(双屏)



15.6" 屏
(壁挂)

本产品分为收银版和生态版

极简设置

开启自助服务终端设备，只需几步

- 1 按电源键，屏幕点亮，进入首次开机界面，按提示操作即可。
本机可选择2种上网模式。
- 2 WiFi设置
 - 点击【设置】按钮，然后开启WLAN，进入WLAN搜索界面，等待其搜索并列出可用的WLAN热点；
 - 点击要连接的WLAN，若选择一个加密的网络，则需要输入访问密码方可连接。
- 3 LAN设置
 - 采用网线连接网络

如何下载/使用应用

本自助服务终端适用于便利店、百货店、餐饮服务业、自助售票、民生服务等不同业态环境。相关应用可在联网模式下，打开应用市场，浏览并下载应用即可完成安装。

系统预置软件列表

- 应用市场 · 耗材商城 · 推送服务 · 用户反馈 · 数据服务 · 双屏服务
- 双屏设置 · 远程控制 · 硬件管家 · 打印服务 · 欢迎界面 · 用户中心
- 公共Wi-Fi · 扫码SDK · 启动器 · OTA
- 电子说明书 · 打印机缺纸报警 · 音量键功能自定义
- SunmiRecoveryOTA · 系统Intent拦截Service · 开发者指南（调试小助手）
- 系统权限API服务（应用市场配套） · 定制服务（壁纸、开机动画）

以上软件详细信息查询方法：选择“设置->应用”，选择相应软件名称进行查看信息；
软件卸载方法：选择“设置->应用->管理应用->卸载”卸载应用；或长按图标，拖曳到垃圾桶卸载。

更多使用帮助请阅读机内帮助 APP

产品简介

“以双屏为例”

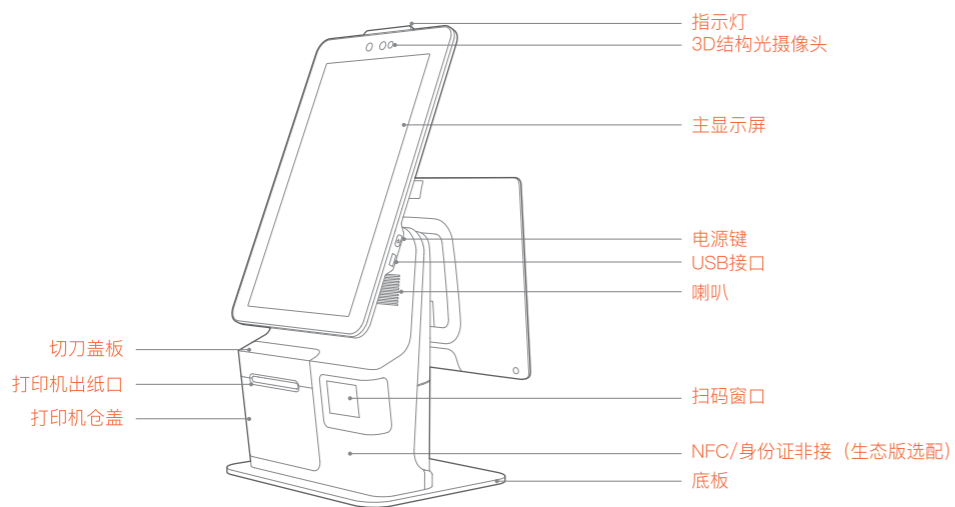

电源键

关机状态下，短按开机启动；
使用状态下，长按2-3秒，可选择关机或重启；
开机状态下，长按11秒，断电关机。

USB接口

用于外接键盘、鼠标、U盘。

打印机出纸口

用于开机状态下打印单据。

指示灯

提示警示灯。

3D结构光摄像头

用于拍摄人脸的摄像头。

主显示器

用于客户使用的触摸屏。

条码扫描窗

用于扫描手机付款码及商品码。

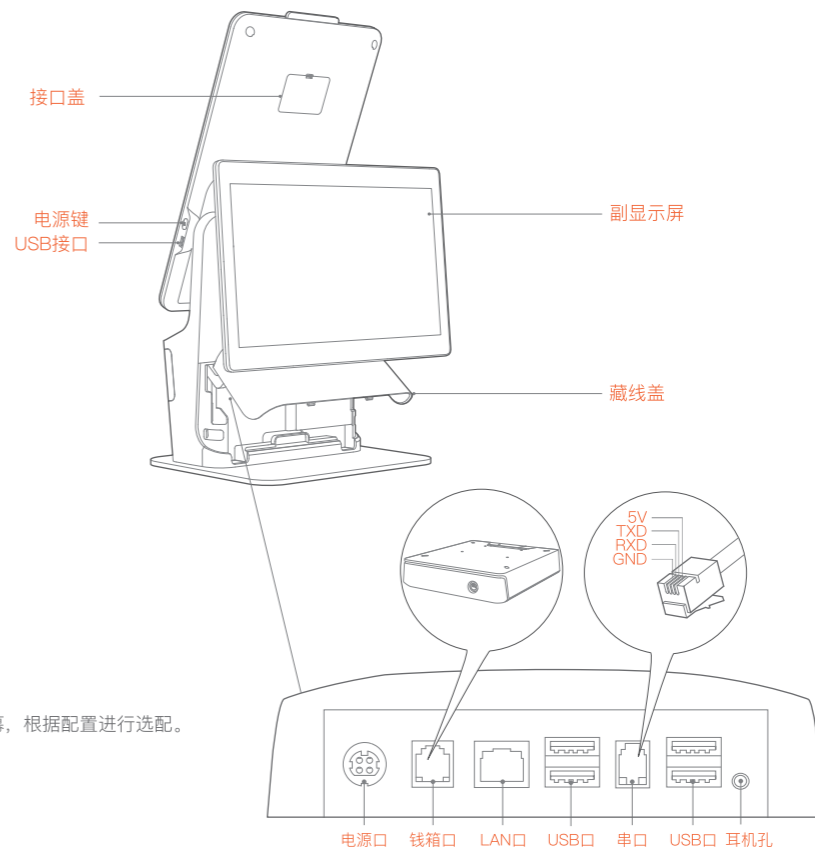

副显示屏

用于营业员端使用的屏幕，根据配置进行选配。

藏线盖

打开以后进行线缆插拔。

钱箱口

用于外接钱箱，输出120ms电脉冲，不会持续供电。
本设备只支持外接24V/1A钱箱，如果使用12V钱箱，可能存在烧毁钱箱电路隐患。

58打印纸安装

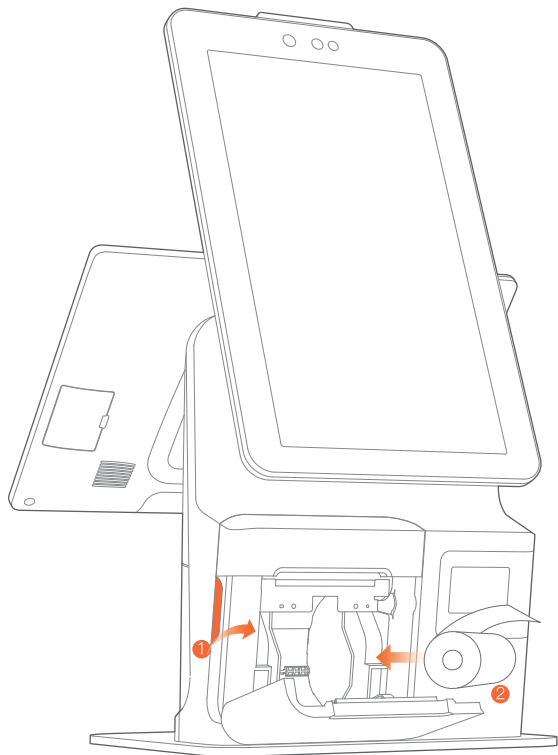

① 打开打印机纸仓盖

向外拉打印机仓盖，仓盖自动弹开。

② 安装打印纸

放入58热敏纸并拉出一段于打印纸口外，再关好仓盖。

80打印纸安装

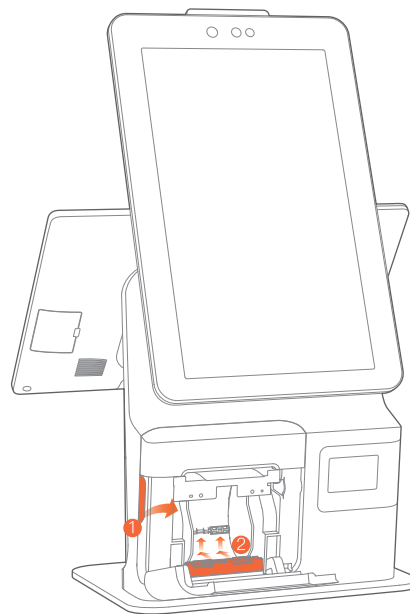

① 打开打印机纸仓盖

向外拉打印机仓盖，仓盖自动弹开。

② 取下纸卷前挡块

将纸卷前挡块后推并上提取下。

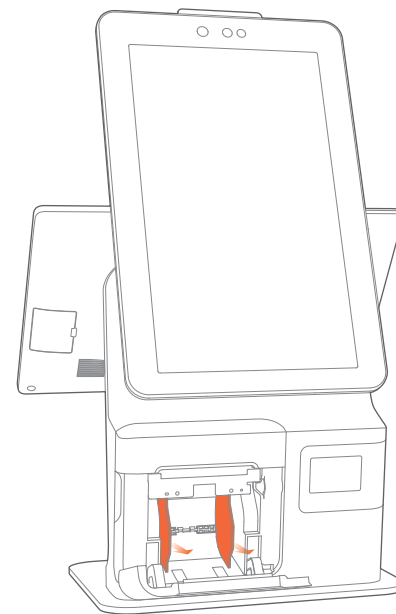

③ 取下纸卷隔板

将两块纸卷隔板向外拉出取下。

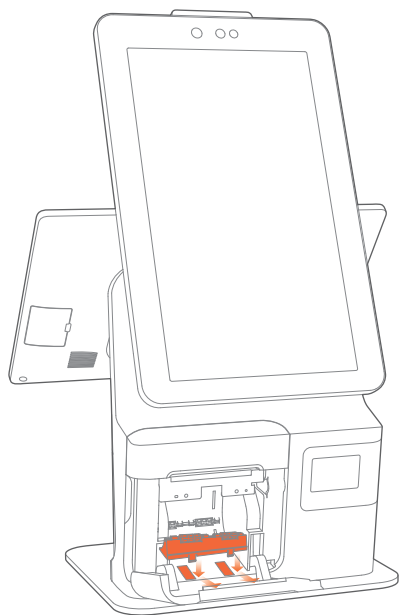

④ 安装纸卷前挡板

将纸卷前挡板向下并向后安装。

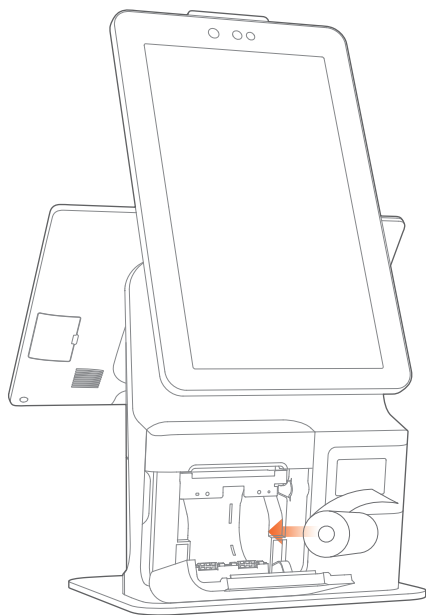

⑤ 安装打印纸

放入80热敏纸并拉出一段于打印纸口外，再关好仓盖。

打印纸错误操作

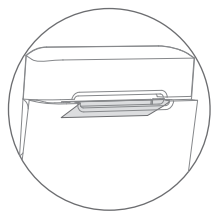

请勿将打印纸放斜。

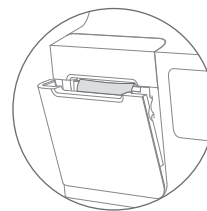

请勿让打印机仓盖压住打印纸。

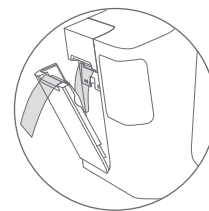

请勿将打印纸拉扯过长形成折叠。

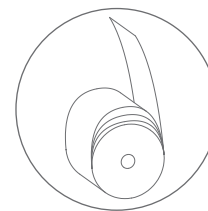

请勿将松散的打印纸放入纸仓内使用。

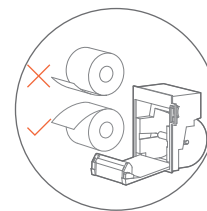

请注意打印纸的正确朝向。

卡刀故障排除操作

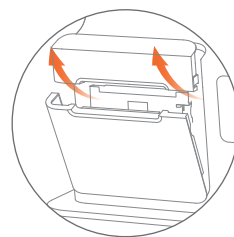

① 先将切刀盖板向上打开，取下切刀盖板。



② 再向下旋转切刀旋钮，直至卡刀解除。

壁挂式整机安装步骤

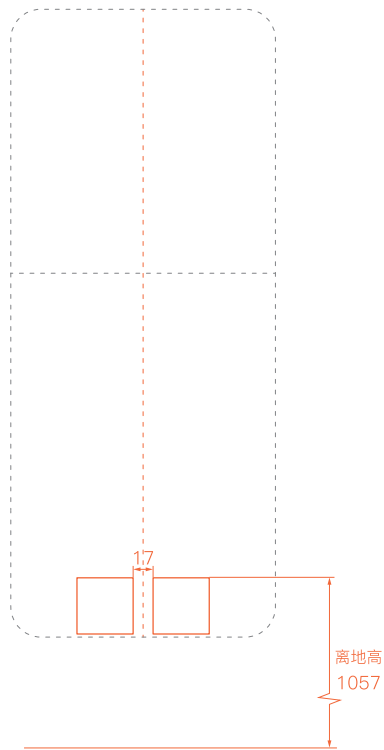

1 布置插座

按上述尺寸布置86规格三孔电源插座以及单孔网口插座。

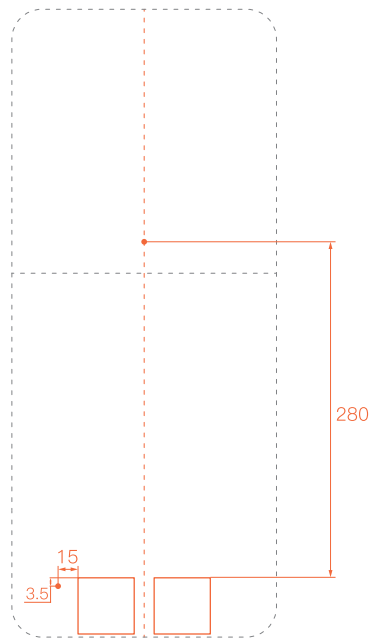

2 安装壁挂螺钉

按上述高度与尺寸在墙面打孔： $\phi 8 \times 80$ ；
在孔中安装 $\phi 8 \times 60$ 塑料膨胀管；
在各个膨胀管上安装M5螺钉
(螺钉不完全拧紧，预留3mm)；

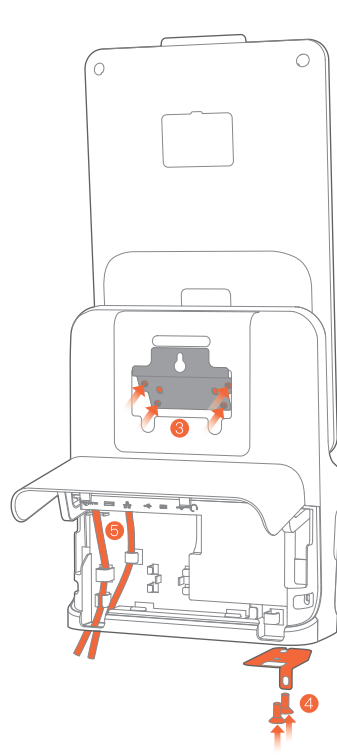

3 将壁挂支架固定在主机

将壁挂支架用4个M4螺钉与主机拧紧固定。

4 安装固定板

将壁挂固定板用2个M6螺钉与主机拧紧固定。

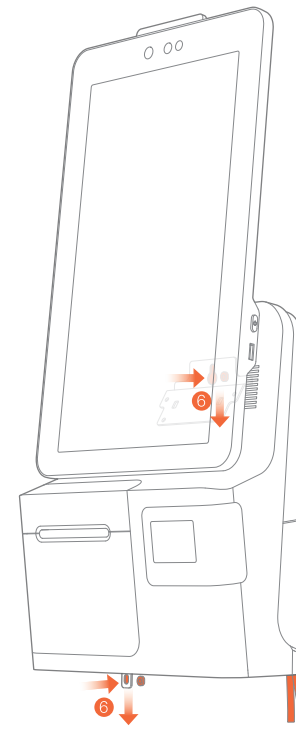

5 接插线缆

将电源线与网线从机柜开孔中穿过，
并插好主机端插头。

6 固定主机

将主机挂在2个M5螺钉上并拧紧。

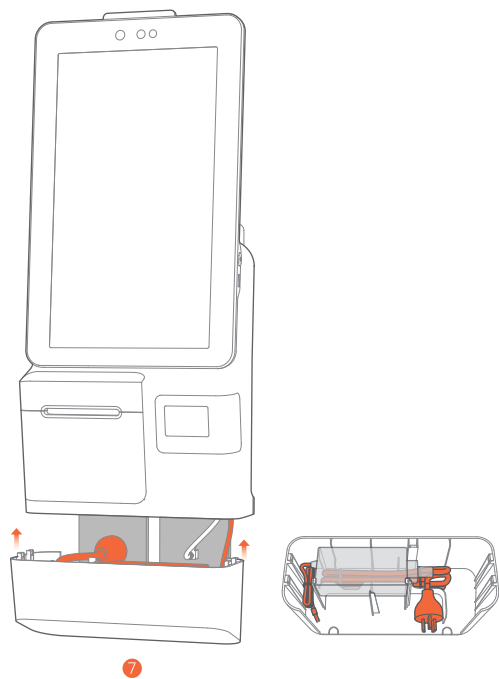

7 安装适配器盒

将电源插头和网线水晶头插入墙面插板；
将适配器放入适配器盒中；
将适配器盒固定在主机上。

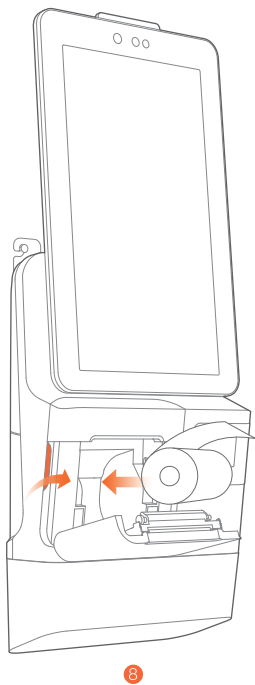

8 装入打印纸

打开打印机仓盖，装入打印纸。

常见故障排除

症状	解决方法
死机怎么办	· 长按电源键11秒，进入断电关机，短按重新开机。
网络无法连接	· 请检查连接到K2 MINI的网络是否正常； · 尝试重启K2 MINI。
身份证识别失败	· 请确认是否为第二代、三代身份证； · 重启系统或拨打相关保修热线。
摄像头刷脸异常	重启系统或拨打相关保修热线。
打印机不工作	· 确认纸仓盖正确关闭； · 确认是否发生卡纸故障
打印内容空白	· 请检查纸卷是否放反； · 请检查是否使用了80mm的热敏打印纸卷。
打印内容模糊	· 请检查热敏头片是否脏污，如果脏污，请使用棉签蘸无水酒精进行擦拭； · 请更换品质有保障的热敏纸，避免因为纸质引起的打印不清。

自助服务终端基本参数

操作系统	Android 7.1 (SUNMI OS)
处理器	8核处理器/RK4核处理器
存储	16GB ROM+ 2GB RAM
触显一体屏 (竖屏)	15.6英寸分辨率FHD1080 x 1920, 十点触控电容屏
触显一体屏 (横屏)	15.6英寸分辨率FHD1920 x 1080, 十点触控电容屏 (选配)
以太网	1*LAN: 10/100/1000M自适应
WiFi	双频WiFi支持 802.11 a/b/g/n/ac(2.4Ghz/5Ghz)
蓝牙	支持蓝牙4.2
打印机	58/80mm宽度打印机头, 带自动切刀
扫码器	单窗扫码平台, 支持手机屏幕及印刷的一维、二维条码
摄像头	3D结构光高清摄像头
身份证阅读+非接	读取第二代身份证; 支持M1\ID\CPU卡读写(生态版选配)
喇叭	单个3W
外部接口	5x USB typeA口, 1x RJ11串口, 1x RJ12 钱箱口, 1x RJ45 LAN口, 1x耳机口, 1x电源口, 1x Micro-USB调试口
外部存储卡	支持MicroSD(TF), 最大到64GB
电源适配器	输出功率60W, 输入: AC100~240V/1.7A, 输出: DC24V/2.5A
使用环境	温度: 0°C~40°C, 湿度: 25%~90%
存储环境	温度: -20°C~55°C, 湿度: 93% (40°C、非凝聚态)

整机外形尺寸参数

	主机尺寸/重量
双屏	宽380mm × 深280mm × 高590mm, 重量: 10.5Kg
单屏	宽300mm × 深250mm × 高590mm, 重量: 8Kg
壁挂	宽265mm × 深120mm × 高680mm, 重量: 5Kg

自助服务终端主机包装清单

<input type="checkbox"/>	K2 MINI主机	1台	
<input type="checkbox"/>	附件盒	1件	
<input type="checkbox"/>	打印纸	1件	装在附件盒中
<input type="checkbox"/>	主机电源线 (国标)	1根	装在附件盒中
<input type="checkbox"/>	用户指南	1本	包含包装内容、产品保修卡、产品合格证
<input type="checkbox"/>	壁挂组件	2个	(壁挂标配)
<input type="checkbox"/>	主机网络线	1根	装在附件盒中 (壁挂标配)
<input type="checkbox"/>	适配器盒	1个	(壁挂标配)
<input type="checkbox"/>	螺丝包	1套	装在附件盒中 (壁挂标配)

本产品有毒有害物质名称及含量标识表

部件名称	有毒有害物质或元素					
	铅 (Pb)	汞 (Hg)	镉 (Cd)	六价铬 (Cr(VI))	多溴联苯 (PBB)	多溴二苯醚 (PBDE)
电路板组件	×	○	○	○	○	○
壳体组件	○	○	○	○	○	○

○：表示该有毒有害物质在该部件所有均质材料中的含量均在SJ/T11363-2006规定的限量要求以下。
×：表示该有毒有害物质至少在该部件的某一均质材料中的含量超出SJ/T11363-2006规定的限量要求；
但是上表中打“×”的部件，其含量超出是因为目前业界还没有成熟的替代的技术。

对达到或超出环保使用年限的产品，应依据《电子信息产品控制管理办法》规定进行回收再利用，不应随意丢弃。

产品保修卡

产品名称：_____ 以下情况恕不提供免费保修：
产品型号：_____ · 未经允许擅自拆卸修理的产品。
产品编号：_____ · 产品条码、易碎贴破损及保修卡涂改、残缺的。
购买日期：_____ · 未按照说明书的要求操作设备所引起的故障。
保修期限：自购买之日起，我公司提供 ____ 天保修服务。 · 因进水或跌落而造成的故障、划伤或破损的人为损坏。
联系方式：_____ · 因不可抗拒因素造成的故障或损坏。
· 公司地址：_____ · 保修期限外。
· 联系电话：_____

产品合格证

检验合格

制造商：上海商米科技集团股份有限公司
地址：上海市杨浦区淞沪路388号创智天地7号楼505室
邮箱：contactus@sunmi.com
热线电话：400-6666-509

注意事项

安全警告

- 请将交流电插头插入与配件电源适配器上标识输入相对应的交流电插座中；
- 严禁在存有任何潜在爆炸性气体的场所使用；
- 非专业人员不要随意打开电源适配器，以免发生危险；
- 此为A级产品。在生活环境中，该产品可能会造成无线电干扰。在这种情况下，可能需要用户对于干扰采取切实可行的措施。

关于电池的更换：

1. 用错误型号电池更换会有爆炸危险！
2. 更换后的旧电池应交维修人员处置，切勿把它投入火中！

重要安全说明

- 避免在雷电期间安装或使用，否则有被雷电电击的危险；
- 当您发现有异常气味，过热或烟雾情形下，请立刻切断电源；
- 撕纸刀较锋利，请勿触碰！

建议

- 不要在靠近水或潮湿环境中使用，避免液体落入终端中；
- 不要在极端冷、热环境中使用，例如靠近火源或点燃的香烟；
- 不要摔、投掷或弯折；
- 尽量在清洁无尘环境中使用，避免细小物品落入终端中；
- 在未获允许的情况下，不要在医疗设备附近使用。

声明

本公司不对以下行为负责

- 不在本指南说明的条件下使用和维护所造成的损坏；
- 对于如何因选件或耗材（非本公司提供之最初产品或认可产品）造成的损坏或问题，本公司将不承担任何责任。未经本公司同意，无权进行产品修改或变动。

免责声明

由于产品的更新，此文档的某些细节可能与产品不符，请以实物为准，此文档的解释权归本公司。保留不预先通知的情况下，修改本说明书的权利。

使用产品前请仔细阅读本使用说明书，并妥善保管
上海商米科技集团股份有限公司 版权所有

Three installation styles of K2 MINI

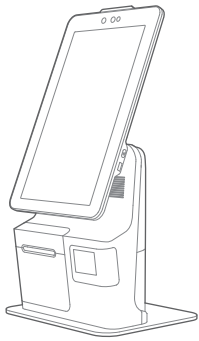

Single screen desktop

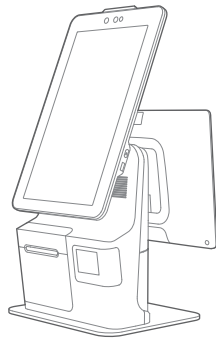

Dual screen desktop



Wall-mounted

Quick Setting

Only several steps to enable the smart commercial device K2 MINI:

- 1 After turning on the complete machine power supply, the screen will be lit. Then you will enter the first boot interface and just simply operate according to the instructions. There are two types of internet mode available for you.
- 2 LAN setting
After plugging the network cable correctly, click "Setting" and "Wired Network" to choose Enable. Access password is required for an encrypted network connection. As for IP address, there are two options: to automatically obtain IP or to manually enter IP address.
- 3 Wi-Fi setting
Click "Setting" and "WLAN" to enter the WLAN search interface. Wait for the available WLAN hot spots searching and listing. Click the right WLAN to connect to the network. Access password is required for an encrypted network connection.

How to download/use App

The Self-Checkout Kiosk is applicable for the cashier environment of commercial customers in various industries, such as convenience stores, department stores, catering, self service ticketing, livelihood services, etc. Please turn on the Kiosk and search & download the relevant Apps on the App market on Internet.

 Facebook: Sunmittech

 LinkedIn: SUNMI Technology

Please read the internal machine help App for more help or call 400-6666-509 for free telephone services.

Brief Introduction of K2 MINI

Based on Dual screen desktop

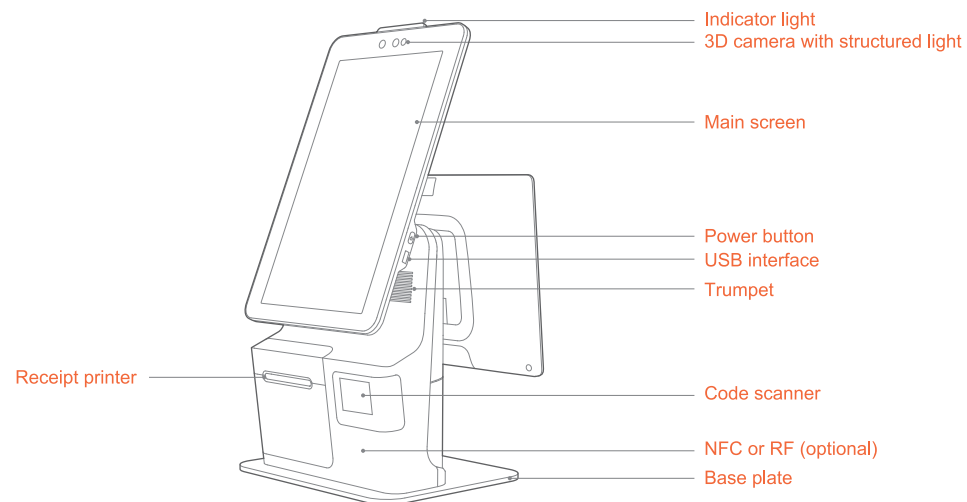

System switch

In standby state, short press to boot, short press again to be in standby mode;
In service state, long press for 2 to 3 seconds to choose to shut-down or restart;
In the state of power-on, long press for 11 seconds to shut down the host.

USB interface

For cash box, keyboard, scanner etc.

Receipt printer

Used to print receipt.

Indicator light

Indicate different status of kiosk.

3D camera with structured light

Used for Face-ID verification, Payment.

Main screen

For customer usage.

Code scanner

Support commodity barcode & payment QR code.

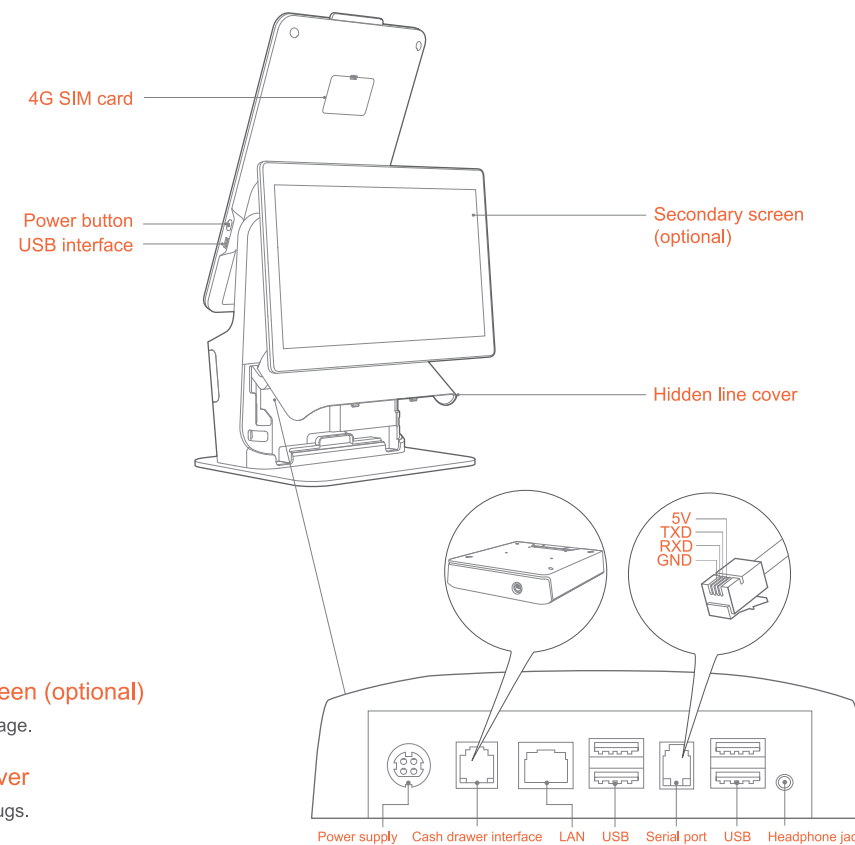

Secondary screen (optional)

Used for salesperson Usage.

Hidden line cover

Cover the cable plugs.

Cash drawer interface

Used for external cash drawer, output 120ms electric pulse, will not continuously supply power;
Only supports 24V/1A cash drawer.

Installation Steps of 58mm Thermal Paper Roll

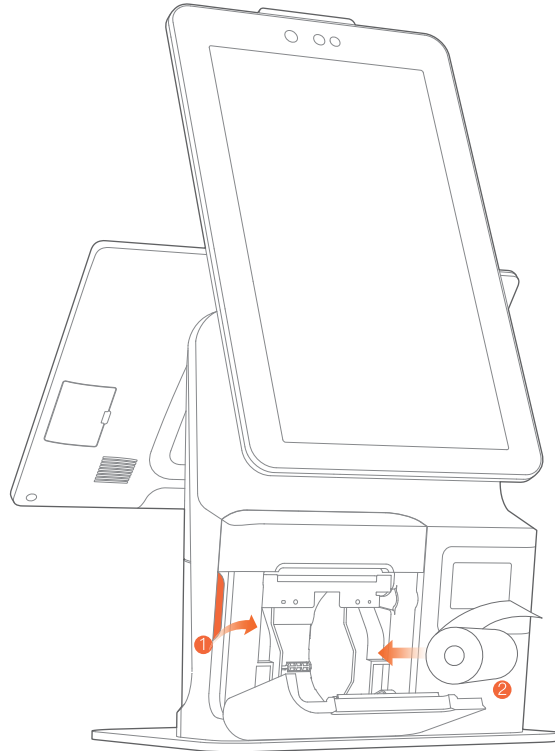

① Open paper storage cover

Pull the printer cover outside and it will pop open automatically.

② Load print paper roll

Put in the 58mm thermal sensitive paper and pull out a section outside the printer exit.

Installation Steps of 80mm Thermal Paper Roll

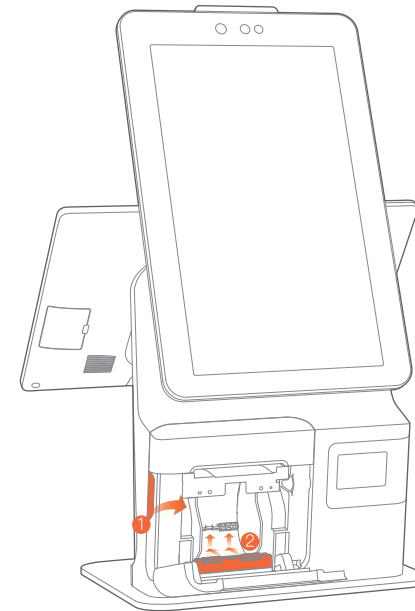

① Open paper storage cover

Pull the printer cover outside and it will pop open automatically.

② Remove the front stop of the paper roll

Push back the two buckles at the bottom and lift up.

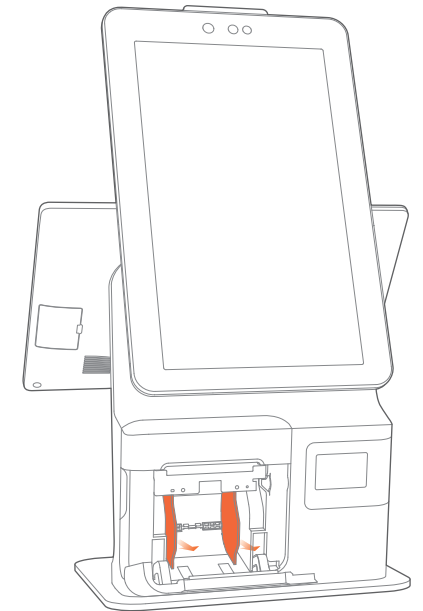

③ Remove Paper roll separator

Pull out two paper roll separators.

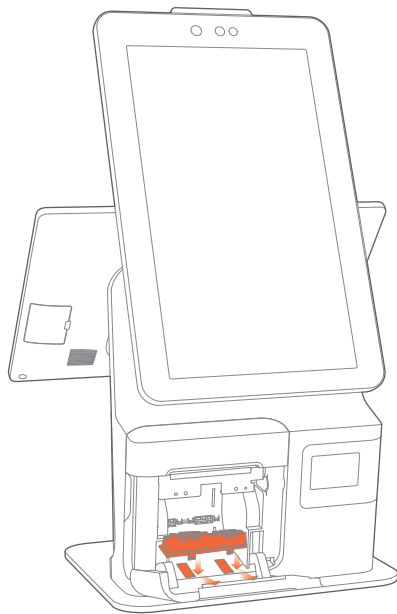

④ Load the front stop of the paper roll

Put it down into the slot and push it backwards.

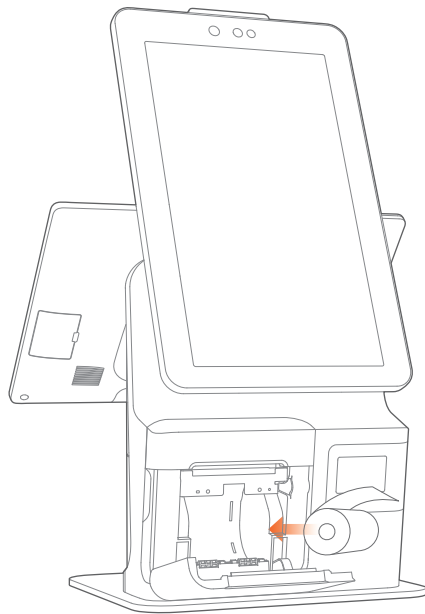

⑤ Load print paper roll

Put in the 80mm thermal sensitive paper and pull out a section outside the printer exit.

Print Paper Misoperation

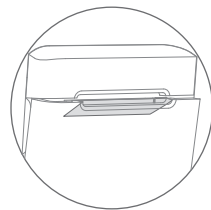

Do not skew the paper.

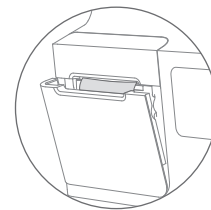

Do not let the printer cover hold the paper.

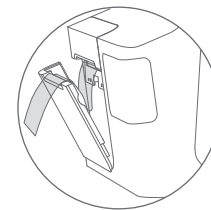

Do not pull the paper too long to form a fold.

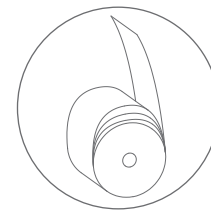

Do not put loose paper in the paper bin.

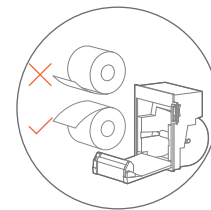

Please note the correct orientation of the paper

Troubleshooting for Cutter Issue

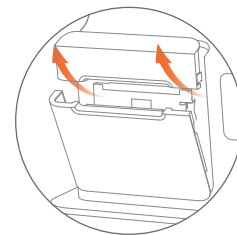

① First open the cutter cover and remove the cutter cover.



② Turn the cutter knob downwards until the cutter is released.

Installation Steps of Wall-mounted

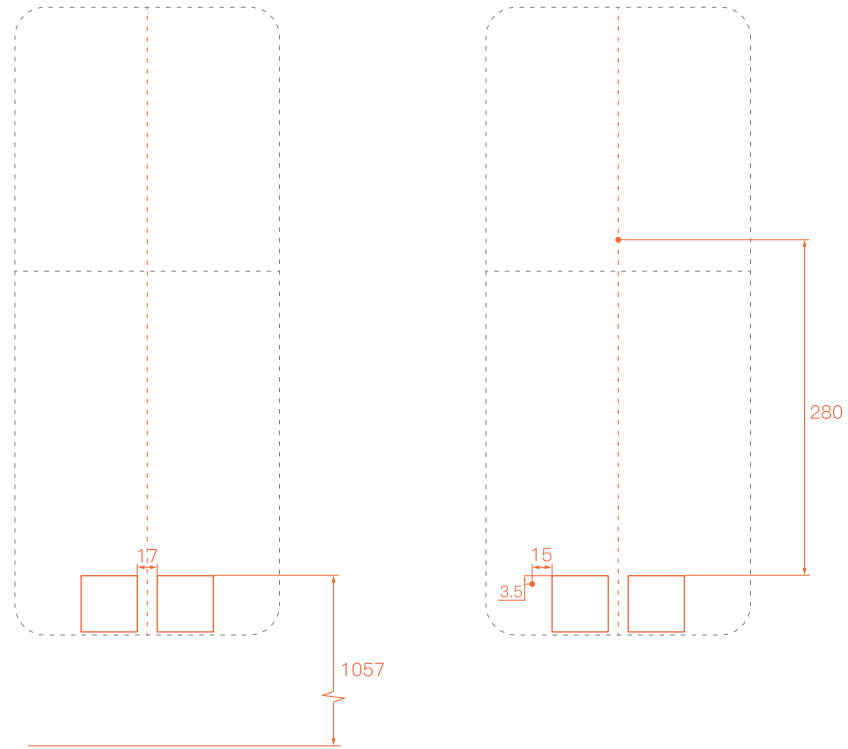

1 Arranging electrical outlets

Arrange 86-size three-hole power supply and network port socket according to the above dimensions.

2 Installing wall screws

According to the above dimensions, Punch 3 holes in the wall $\Phi 8 \times 80$; Put in the plastic expansion tube and install 3 M5 screws, reserved 3mm length.

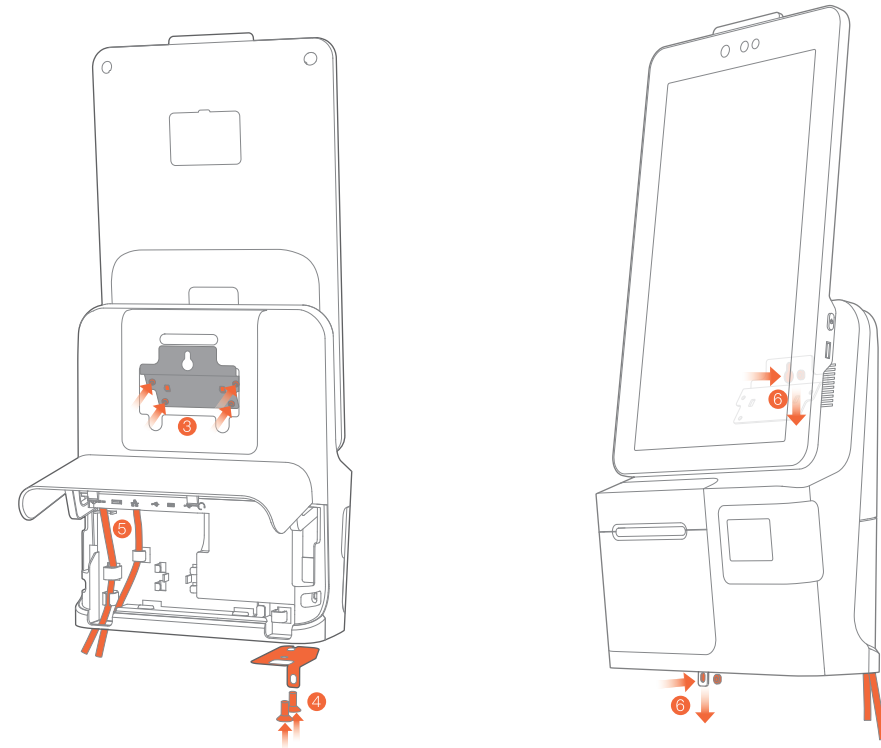

3 Installing the wall mount bracket

Use 4pcs M4 screws fix to the host.

4 Installing the retainer plate

Use 2pcs M6 screws fix to the host.

5 Patch cables

Pass the power cable and network cable through the opening of the host, and plug it in.

6 Fixed host

Hang the host on 2pcs M5 screws and tighten the screws.

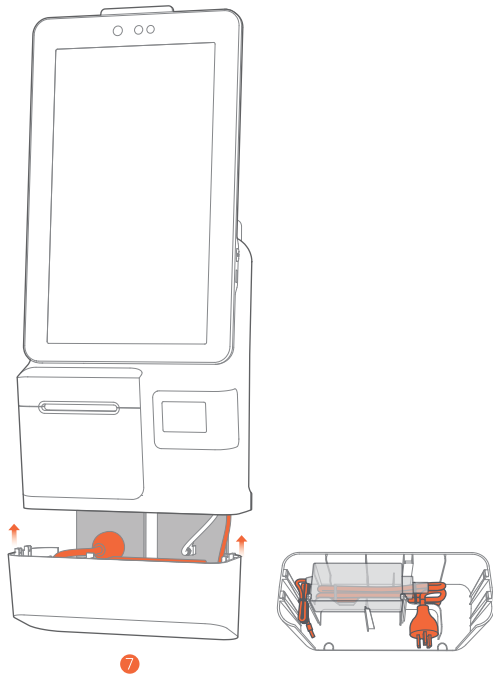

7 Install the adapter box

Plug the power and network cables into the wall socket;
Put the power adapter into the box;
Fix the box onto the host.

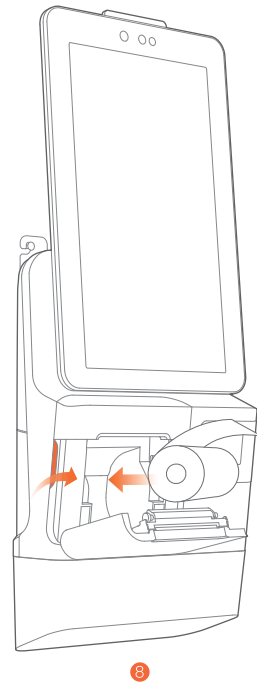

8 Load print paper roll

Open the printer cover and
load the paper roll.

Common Troubleshooting

Problems	Solutions
System is stuck	<ul style="list-style-type: none"> · Long press the power button for 11 seconds to force shutdown; short press to restart.
Network cannot connect	<ul style="list-style-type: none"> · Check the network status; · Try to restart the K2 MINI.
Camera does not work	<ul style="list-style-type: none"> · Try to restart the K2 MINI or call the 400-6666-509.
Printer does not work	<ul style="list-style-type: none"> · Please make sure the cover is closed correctly; · Please double check if there is the paper jam.
Print content is blank	<ul style="list-style-type: none"> · Please check if the paper roll is installed in the wrong direction; · Please check if use the 80mm paper roll.
Blurred print	<ul style="list-style-type: none"> · Please check whether the thermal head is dirty, if it is, please wipe with anhydrous alcohol; · Please replace the thermal paper with guaranteed quality to avoid unclear printing caused by the paper quality.

Basic Parameters of K2 MINI

Operating system	Android 7.1 (SUNMI OS)
Processor	Rockchip Quad-core
Storage	Memory:16G ROM+2G RAM
Display	Portrait screen-15.6" 1080*1920 FHD G+G capacitive multi touch Screen; Landscape(optional)-15.6" 1920*1080 FHD G+G capacitive multi touch Screen;
Ethernet	1*LAN: 10/100/1000M adaptive
WiFi	2.4/5 GHZ,support IEEE 802.11a/b/g/n/ac
Bluetooth	Support Bluetooth 4.2
Printer	58/ 80mm thermal printing with automatic cutter
Bar code scanning	Support 1D & 2D code of mobilephone screen or Paper
Face camera	3D camera with structured light; Support FR payment, membership verification, etc.
NFC or RF	Used for NFC payment or RF quick pass(optional)
Trumpet	3W
External interface	5x USB typeA, 1x RJ11 Serial port, 1x RJ12 Cashbox port, 1x RJ45 LAN 1x Headphone jack, 1x Power port, 1x Micro-USB Debug port
Extended memory	Support MicroSD(TF),up to 64GB
Power supply	Input: AC100~240V/1.7A; Output: DC24V/2.5A,60W
Operational environment	Temperature: 0°C~40°C; Humidity: 25%~90%
Storage environment	Temperature: -20°C~55°C; Humidity: 93% (40°C,non-condensing)

Parameters of Complete Machine

	Host size / Weight
Dual screen desktop	380mm width × 280mm length × 590mm depth, weight: 10.5Kg
Single screen desktop	300mm width × 250mm length × 590mm depth, weight: 8Kg
Wall-mounted	265mm width × 120mm length × 680mm depth,weight: 5Kg

Package packing List of K2 MINI Host

<input type="checkbox"/>	K2 MINI Host	1	
<input type="checkbox"/>	Accessory Box	1	
<input type="checkbox"/>	Printing paper	1	In accessory box
<input type="checkbox"/>	Host power line(National standard)	1	In accessory box
<input type="checkbox"/>	User Manuel	1	Including packing content, warranty card and certificate
<input type="checkbox"/>	Wall-mounted components	2	(Wall-mounted)
<input type="checkbox"/>	Host network cable	1	In accessory box (Wall-mounted)
<input type="checkbox"/>	Power adapter box	1	(Wall-mounted)
<input type="checkbox"/>	Screw bag	1	In accessory box (Wall-mounted)

Table for Names and Content Identification of Toxic and Hazardous Substances in this Product

Part Name	Toxic or Hazardous Substances and Elements									
	Pb	Hg	Cd	Cr(VI)	PBB	PBDE	DEHP	DBP	BBP	DIBP
Circuit Board Component	X	○	○	○	○	○	○	○	○	○
Structural Component	○	○	○	○	○	○	○	○	○	○
Packaging Component	○	○	○	○	○	○	○	○	○	○

○: indicates that the content of the toxic and hazardous substance in all homogeneous materials of the component is below the limit specified in SJ/T 11363-2006.

X: indicates that the content of the toxic and hazardous substance in at least one homogeneous material of the component exceeds the limit stipulated in SJ/T 11363-2006. However, as for the reason, because there is no mature and replaceable technology in the industry at present.

The products that have reached or exceeded environmental protection service life should be recycled and reused according to the Regulations on Control and Management of Electronic Information Products, and should not be discarded randomly.

Product warranty card

Product Name: _____

Product model: _____

Product No.: _____

Date of purchase: _____

Warranty period: from the date of purchase, our company provides ____ day warranty service.

Contact information:

· Company address: _____

· Contact number: _____

Free warranty is not available for:

- Dismantle and repair the product without permission.
- The bar code and fragile stickers of the product are damaged, and the warranty card is altered or incomplete.
- Failure to operate the equipment in accordance with the instructions.
- Artificial damage caused by failure, scratch or damage due to water inflow or falling.
- Failure or damage caused by force majeure.
- Beyond the warranty period.

Product certificate

Inspection Qualified

Manufacture: Shanghai SUNMI Technology Co., Ltd.
Address: Room 505, Building 7, No. 388, Songhu Rd, Shanghai, China.
Mail: contactus@sunmi.com
Phone: 400-6666-509

Points for Attention

Safety warning

Please plug the AC plug into the AC socket corresponding to the identification input on the power adapter of the accessory;

· It is strictly forbidden to use it at a site with the existence of any potential explosive gas;

· Risk of fire or explosion if the battery is replaced by an incorrect type;

· This is a professional equipment, so no-professionals are not allowed to open the internal module at will, to avoid danger.

· This is a A grade product. In the living environment, this product may cause radio interference.

In this case, the user maybe required to apply feasible measures against the interference.

Points for attention about the power supply

· Please unplug the plug from the power supply AC socket to completely disconnect the power supply connection of the device;

· The power supply socket should be installed near the device, and be easy to contact.

Important Safety Instructions

· Avoid it to be installed or used during the thunder & lightning period, otherwise there will be risk of being electrically shocked by it;

· When you have discovered unusual odor, overheat or smog, please cut off the power supply at once!

· The paper knife is relatively sharp, please don't touch it!

Statement

Our company will not be responsible for the results of the following actions

Damage caused by usage & maintenance not under the conditions of this guidance note;

Our company will not be responsible for any damage or problem caused by any option or consumable (not the initial product or recognized product provided by our company). You have no right to make product company;

FCC Statement

· Please take attention that changes or modification not expressly approved by the party responsible for compliance could void the user's authority to operate the equipment.

· This device complies with Part 15 of the FCC Rules. Operation is subject to the following two conditions:

· (1) This device may not cause harmful interference, and

· (2) This device must accept any interference received, including interference that may cause undesired operation.

· This equipment complies with FCC radiation exposure limits set forth for an uncontrolled environment. This equipment should be installed and operated with minimum distance 20cm between the radiator & your body.

Suggestions

· Do not use it near the water or in the humid environment, to prevent the liquid from dropping into the terminal;

· Do not use it in extreme cold or hot environment. For example: near the ignition source or lighted cigarette;

· Do not drop, throw or bend it;

· Try best to use it in clean and dust-free environment, to prevent small items from dropping into the terminal;

· Do not use it nearby the medical devices when not allowed.

Disclaimer

Due to the product update, certain details of this document may be inconsistent with the product.

Please refer to the material item. Our company owns the interpretative right of this document. We reserve the right to modify this user guide without giving advance notice.

The End